



**INSTALLATION MANUAL
OF STANDARD SOLAR
MODULES (IEC)**

1.0	GENERAL INFORMATION	4
1.1	INSTALLATION MANUAL DISCLAIMER	4
1.2	LIMITATION OF LIABILITY	4
2.0	SAFETY PRECAUTIONS	4
3.0	MECHANICAL / ELECTRICAL SPECIFICATIONS	5
4.0	UNPACKING AND STORAGE	6
5.0	MODULE INSTALLATION	7
5.1	MODULE WIRING	8
5.2	GROUNDING	8
6.0	MOUNTING INSTRUCTIONS	9
6.1	MOUNTING METHOD: BOLTING	10
7.0	MAINTENANCE	11
	AMENDED EDITIONS AND DATES	12

1.0 GENERAL INFORMATION

This general manual provides important safety information relating to the installation, maintenance and handling of CS-series solar modules.

Professional installer must read these guidelines carefully and strictly follow these instructions. Failure to follow these instructions may result in death, injury or property damage. The installation and handling of PV modules requires professional skills and should only be performed by qualified professionals. The installers must inform end-users (consumers) the aforesaid information accordingly. The word "module" or "PV module" used in this manual refers to one or more CS-series solar modules.

This manual is only valid for the module types CS6A-xxxP, CS6A-xxxM, CS6V-xxxP, CS6V-xxxM, CS6P-xxxP, and CS6P-xxxM, CS6K-xxxP, CS6K-xxxM, CS6X-xxxP, CS6X-xxxM, CS6K-xxxMS., CS6V-xxxMS, CS6A-xxxMS, CS6U-xxxP and CS6U-xxxM.

Please retain this manual for future reference. We recommend checking www.canadiansolar.com regularly for the most updated version.

1.1 INSTALLATION MANUAL DISCLAIMER

The information contained in this manual is subject to change by Canadian Solar Inc. without prior notice. Canadian Solar Inc. gives no warranty of any kind whatsoever, either explicitly or implicitly, with respect to the information contained herein.

1.2 LIMITATION OF LIABILITY

Canadian Solar Inc. shall not be held responsible for damages of any kind, including – without limitation – bodily harm, injury or damage to property, in connection with handling PV modules, system installation, or compliance or non-compliance with the instructions set forth in this manual.

2.0 SAFETY PRECAUTIONS

Warning
 Before attempting to install, wire, operate and/or service the module and other electrical equipment, all instructions should be read and understood. PV module interconnectors pass direct current (DC) when exposed to sunlight or other light sources. Contact with electrically active parts of the module, such as terminals, can result in injury or death, irrespective of whether or not the module and the other electrical equipment have been connected.

GENERAL SAFETY

- All installation work must comply with applicable regional and local regulations or other national or international electrical standards.

 Protective clothing (non-slip gloves, clothes, etc.) must be worn during installation to prevent direct contact with 30 V DC or greater, and to protect your hands against sharp edges.

 Prior to installation, remove all metallic jewelry to prevent accidental exposure to live circuits.

 When installing modules in light rain, morning dew, take appropriate measures to avoid water permeate into the connector.

 **Do not** allow children or unauthorized persons near the installation site or storage area of modules.

- When installing modules in strong wind, take appropriate safety measures to avoid damage to the modules or injuries to people.
- Use electrically insulated tools to reduce the risk of electric shock.
- If the disconnects and OCPD's cannot be opened or the inverter cannot be powered down, cover the fronts of modules in the PV array with an opaque material to stop the production of electricity when installing or working on a module or wiring.

- **Do not** use or install broken modules.
- Contact with module surfaces or frames may cause electric shock if the front glass is broken or the backsheet is torn.
- The PV module does not contain any serviceable parts. Do not attempt to repair any part of the module.
- Keep the junction box cover closed at all times.
- **Do not** disassemble a module or remove any module part.
- **Do not** artificially concentrate sunlight on a module.
- **Do not** connect or disconnect modules when current from the modules or an external source is present.

3.0 MECHANICAL / ELECTRICAL SPECIFICATIONS

Table 1: Low temperature correction factors for open-circuit voltage

Lowest Expected Ambient Temperature (°C/°F)	Correction Factor
24 to 20 / 76 to 68	1.02
19 to 15 / 67 to 59	1.04
14 to 10 / 58 to 50	1.06
9 to 5 / 49 to 41	1.08
4 to 0 / 40 to 32	1.10
-1 to -5 / 31 to 23	1.12
-6 to -10 / 22 to 14	1.14
-11 to -15 / 13 to 5	1.16
-16 to -20 / 4 to -4	1.18
-21 to -25 / -5 to -13	1.20
-26 to -30 / -14 to -22	1.21
-31 to -35 / -23 to -31	1.23
-36 to -40 / -32 to -40	1.25

Module electrical ratings are measured under Standard Test Conditions (STC) of 1000 W/m² irradiance, with an AM1.5 spectrum, and a cell temperature of 25°C. Detailed electrical and mechanical characteristics of Canadian Solar Inc. crystalline silicon PV modules can be found in our Installation Manual Annex (Section Annex C: Module Specifications) on www.canadiansolar.com. Main electrical characteristics under STC are also stated on each module label. Please refer to the datasheet or the product nameplate for the maximum system voltage.

Under certain conditions, a module may produce more current or voltage than under its Standard Test Condition's rated power. As a result, the module short-circuit current at under STC should be multiplied by 1.25, and a correction factor should be applied to the open-circuit voltage (see Table 1 below), when determining component ratings and capacities. Depending on your local regulations, an additional 1.25 multiplier for the short-circuit current (giving a total multiplier of 1.56) may be applicable when sizing conductors and fuses.

Alternatively, a more accurate correction factor for the open-circuit voltage can be calculated using the following formula:

$$C_{VOC} = 1 - \alpha_{VOC} \times (25 - T)$$

T is the lowest expected ambient temperature at the system installation site

α_{VOC} (%/°C) is the temperature coefficient of the selected module (refer to corresponding datasheet)

4.0 UNPACKING AND STORAGE

NOTICE

PRECAUTIONS

- Module should be stored in a dry and ventilated environment to avoid direct sunlight and moisture. If modules are stored in an uncontrolled environment, the storage time should be less than 3 months and extra precautions should be taken to prevent connectors from being exposed to moisture or sunlight.
- Unpack module pallets carefully, following the steps shown on the pallet. Unpack, transport and store the modules with care.
- Modules must always be unpacked by two people. Always use both hands when handling modules.

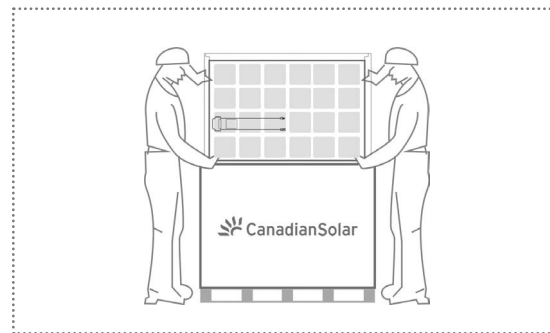

- Do not** stand, step, walk and / or jump on modules under any circumstances. Localized heavy loads may cause severe micro-cracks at cell level, which in turn may compromise module reliability.



- Do not** carry modules on your head.
- Do not** drop or place objects (such as tools) on the modules.
- Do not** lift modules by their wires or junction box, lift them by the frame.
- Stacks of modules should contain no more than 12 modules, and the frames should be aligned.
- Do not** place excessive loads on the module or twist the module frame.
- Do not** use sharp instruments on the modules. Particular care should be taken to avoid module backsheets being damaged by sharp objects, as scratches may directly affect product safety.
- Do not** leave modules unsupported or unsecured.
- Do not** change the wiring of bypass diodes.
- Keep all electrical contacts clean and dry.

PRODUCT IDENTIFICATION

- Each module is equipped with two identical barcodes (one inside the laminate under the front glass, the second on the rear side of the module) that act as a unique identifier. Each module has a unique serial number containing 13 (pre March 2013) or 14 (post March 2013) digits.
- A nameplate is also affixed to the rear of each module. This nameplate specifies the model type, as well as the main electrical and safety characteristics of the module.

5.0 MODULE INSTALLATION



PRECAUTIONS MEASURES AND GENERAL SAFETY

- Prior to installing modules please obtain information about any requirements and necessary approvals for the site, installation and inspection from the relevant authorities.
- Check applicable building codes to ensure that the construction or structure (roof, facade, support, etc.) can bear the module system load.
- CS-series solar modules have been qualified for Application Class A (equivalent to Safety Class II requirements). Modules rated under this class should be used in systems operating at voltage above 50 V or power above 240 W, where general contact access is anticipated.
- When installing modules, please ensure the supporting roof has a fire resistant roof covering rated for the application. Canadian Solar Inc. modules are listed as Class C under the UL790 standard.
- The fire rating for this module is only valid when the product is installed as specified in the mechanical mounting instructions.

ENVIRONMENTAL CONDITIONS

- The module is intended for use in general open-air climates, as defined in IEC 60721-2-1: Classification of environmental conditions Part-2-1: Environmental conditions appearing in nature - Temperature and humidity.
- Please consult the Canadian Solar Inc. technical support department for more information on the use of modules in special climates.



Do not install modules near naked flames or flammable materials.



Do not immerse modules in water or constantly expose modules to water (either fresh or salt) (i.e. from fountains, sea spray).

- Exposing modules to salt (i.e. marine environments) or sulfur (i.e. sulfur sources, volcanoes) incurs the risk of module corrosion.
- Failure to comply with these instructions will void Canadian Solar Inc. warranty.

INSTALLATION REQUIREMENTS

- Ensure that the module meets the general technical system requirements.
- Ensure that other system components do not damage the module mechanically or electrically.
- Modules can be wired in series to increase voltage or in parallel to increase current. To connect modules in series, connect the cables from the positive terminal of one module to the negative terminal of the next module. To connect in parallel, connect the cables from the positive terminal of one module to the positive terminal on the next module.
- The quantity of bypass diodes in the module's junction box may vary depending on the model series.
- Only connect the quantity of modules that corresponds to the voltage specifications of the inverters used in the system. Modules must not be connected together to create a voltage higher than the maximum permitted system voltage, even under the worst local temperature conditions (see Table 1 for the correction coefficients that apply to open-circuit voltage).
- A maximum of two strings can be connected in parallel without the need to incorporate an over-current protection device (fuses, etc.) in series within each string. Three or more strings can be connected in parallel if an appropriate, certified over-current protection device is installed in series within each string.
- Only modules with similar electrical outputs should be connected in the same string to avoid or minimize mismatch effects in arrays.
- To minimize risk in the event of an indirect lightning strike, avoid forming loops when designing the system.

- The recommended maximum series fuse rating is stated in a table in the Annex.
- Modules should be safely fixed to bear all expected loads, including wind and snow loads. A minimum clearance of 6.5 mm (0.25 in) between modules is required to allow for thermal expansion of the frames.
- The small drainage holes on the underside of the module must not be blocked.

OPTIMUM ORIENTATION AND TILT

- To maximize your annual yield, find out the optimum orientation and tilt for PV modules in your region. The highest yields are achieved when sunlight shines perpendicularly onto the PV modules.

AVOID SHADING

- Even minor partial shading (e.g. from dirt deposits) reduces yields. A module can be considered to be unshaded if its entire surface is free from shading all year round. Sunlight should be able to reach the module even on the shortest day of the year.
- Constant shading conditions can affect module service lifetime, due to accelerated ageing of the encapsulation material and thermal stress on the bypass diodes.

RELIABLE VENTILATION

- Sufficient clearance (at least 10 cm (3.94 in)) between the module frame and the mounting surface is required to allow cooling air to circulate around the back of the module. This also enables condensation or moisture to dissipate.

5.1 MODULE WIRING

CORRECT WIRING SCHEME

- Ensure that the wiring is correct before starting up the system. If the measured open circuit voltage (Voc) and short-circuit current (Isc) differ substantially from the specifications, this indicates that there is a wiring fault.

- When modules have been pre-installed but the system has not been connected to the grid yet, each module string should be kept under open-circuit conditions and proper actions should be taken to avoid dust and moisture penetration.

CORRECT CONNECTION OF PLUG CONNECTORS

- Make sure that connections are safe and tight. Plug connector should not be subjected to stress from the exterior. Connectors should only be used to connect the circuit. They should never be used to turn the circuit on and off.

- Connectors are not waterproof when unmated. When installing modules, connector should be connected to each other as soon as possible or appropriate measures should be taken to avoid moisture penetrating into the connector.

USE OF SUITABLE MATERIALS

- Only use dedicated solar cable and suitable plugs (wiring should be sheathed in a sunlight-resistant conduit or, if exposed, should be sunlight-resistant itself) that meet local fire, building and electrical regulations. Please ensure that all wiring is in perfect electrical and mechanical condition.
- Installers may only use single conductor, 2.5-10 mm² (8-14 AWG), 90°C wet rated solar cable, with proper insulation that is able to withstand the maximum possible system open-circuit voltage (i.e. TUV 2PFG1169 approved). Only copper conductor material should be used. Select a suitable conductor gauge to minimize voltage drop.

CABLE AND CONNECTOR PROTECTION

- Secure the cables to the mounting system using UV-resistant cable ties. Protect exposed cables from damage by taking appropriate precautions (e.g. placing them inside a plastic conduit). Avoid exposure to direct sunlight.
- A minimum bending radius of 60 mm (2.36 in) is required when securing the junction box cables to the racking system.
- Do not place connectors in locations where water could easily accumulate.

5.2 GROUNDING

- Although the modules are certified to Safety Class II, we recommend that they be grounded and that module installation should comply with all local electrical codes and regulations.
- Grounding connections should be installed by a qualified electrician.
- Connect module frames together using adequate grounding cables: Canadian Solar recommends using 4-14mm² (AWG 6-12) copper wire. Holes provided for this purpose are identified with a grounding symbol . All conductive connection junctions must be firmly fixed.
- All bolts, nuts, flat washers, lock washers and other relevant hardware should be made of stainless steel, unless otherwise specified.
- Canadian Solar Inc. does not provide grounding hardware.

- One grounding method is recommended for Canadian Solar Inc. standard modules with 5 mm (0.20 in) grounding holes, as described below. For alternative grounding methods, please refer to our Installation Manual Annex (Section Annex B: Alternative Grounding Methods) on the website (www.canadiansolar.com). It is not possible to use standard grounding methods for certain module ranges. Please refer to Annex B for more details.

GROUNDING METHOD: BOLT + TOOTHED NUT + CUP WASHER.

- A grounding kit containing an M5 SS cap bolt, an M5 SS flat washer, an M5 SS cup washer, and an M5 SS nut (with teeth) is used to attach copper grounding wire to a pre-drilled grounding hole on the frame (see image below).
- Place the wire between the flat washer and the cup washer. Ensure that the cup washer is positioned between the frame and the wire with the concave side up to prevent galvanic corrosion. Tighten the bolt securely using the SS toothed nut. A wrench may be used to do this. The tightening torque is 3-7 Nm (2.2-5.2 ft-lbs).

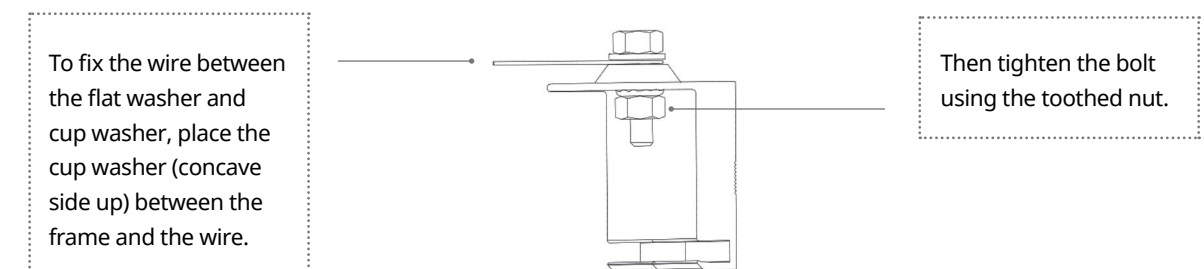

6.0 MOUNTING INSTRUCTIONS STANDARD MODULES

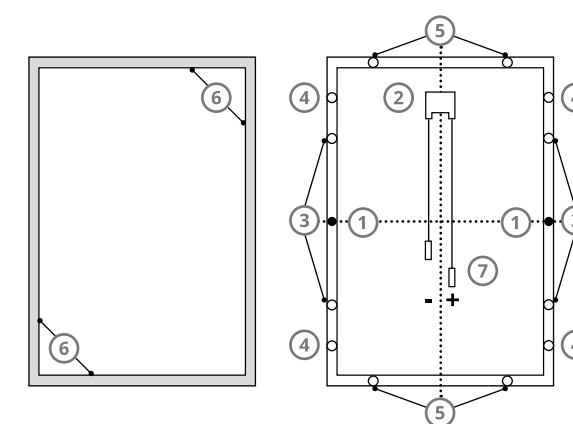

- For a clear understanding of our modules, please refer to the illustration of a standard module shown below:

- ① Grounding holes
- ② Junction box
- ③ Standard mounting holes (long side)
- ④ Additional mounting holes (high wind or snow loads)
- ⑤ Standard mounting holes (short side)
- ⑥ Module frame
- ⑦ Cables and connectors

- The mounting design must be certified by a registered professional engineer. The mounting design and procedures must comply with local codes and requirements from all relevant authorities.
- Canadian Solar Inc. does not provide mounting hardware.
- Standard modules can be mounted onto a support structure using one of several approved methods. One such method is described below. For details of other mounting methods and the methods recommended by Canadian Solar Inc. for special module ranges, please refer to our Installation Manual Annex (Section Annex A: Alternative Mounting Methods) on our website (www.canadiansolar.com). For information about other installation hardware, please contact your local representative. Failure to use a recognized installation method will void the Canadian Solar Inc. warranty.
- Use appropriate corrosion-proof fastening materials. All mounting hardware (bolts, spring washers, flat washers, nuts) should be stainless steel.
- Use a torque wrench for installation.
- **Do not** drill additional holes or modify the module frame. Doing so will void the warranty.
- Standard modules can be installed in either landscape or portrait orientations. Refer to the detailed instructions for further guidance. Please note that in areas with heavy snowfall (> 2400 Pa) further countermeasures such as the use of additional support bars should be considered to avoid snow loads damaging the lowest row of modules.
- In cases where an additional support bar is recommended to improve both mechanical stability and long-term module performance, Canadian Solar recommends selecting sufficiently resistant material. Canadian Solar Inc. recommends bars with a minimum thickness of 50 mm (1.97 in). The support bar centerline should be positioned within 100 mm (3.94 in) of the side frame centerline (slight shifts may be necessary to access module grounding holes).

6.1 MOUNTING METHOD: BOLTING

- The mounting method has been qualified by Canadian Solar Inc. and certified by VDE. Modules should be bolted to support structures through the mounting holes in the rear frame flanges only.
- Each module must be securely fastened at a minimum of 4 points on two opposite sides (exception: M8X1.25-Grade8.8 bolt and nut are used for CS6U and CS6K series modules). Tightening torques should be within 6~12 Nm (4.4-8.9 ft-lbs) and (17~23) Nm (12.5~17.0 ft-lbs) respectively for M6 and M8 coarse thread bolts, depending on bolt class. In areas with heavy wind loads, additional mounting points should be used. The system designer and the installer are responsible for calculating the load and ensuring that the support structure meets the requirements.
- Design load and safety factors will be determined by the racking suppliers or professional engineers. For detailed information, please follow local structural code or contact your professional structural engineer.

Mounting method: Bolting

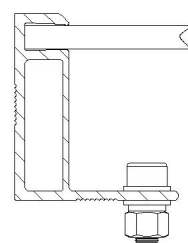

- Modules should be bolted at the following hole locations depending on the configuration and load:

Table 6-1: Approved bolting methods

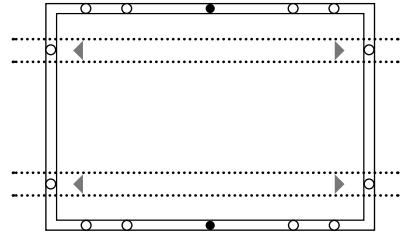
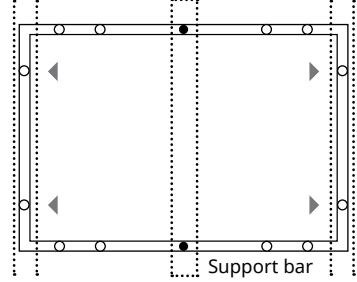
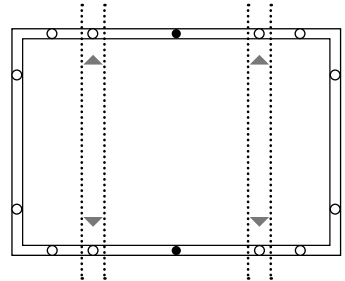
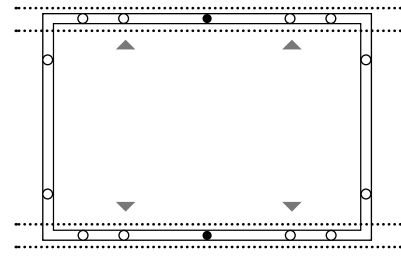
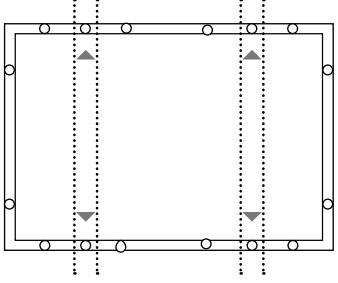
<p>Bolting on short frame side using four standard mounting holes. Mounting rails run perpendicularly to the short frame side</p>  <p>Maximum Load: Uplift load ≤ 2400 Pa Downforce load ≤ 2400 Pa Compatible module type: CS6A-xxxP, CS6A-xxxM, CS6P-xxxP, CS6P-xxxM and CS6A-xxxMS</p>	<p>Bolting on short frame side using four standard mounting holes. An additional support bar should be placed below the module. Mounting rails should run parallel to the short frame side</p>  <p>Maximum Load: Uplift load ≤ 2400 Pa Downforce load ≤ 5400 Pa Compatible module type: CS6A-xxxP, CS6A-xxxM, CS6P-xxxP and CS6P-xxxM</p>
<p>Bolting on long frame side using four innermost mounting holes. Mounting rails run perpendicularly to the long frame side</p>  <p>Maximum Load: Uplift load ≤ 2400 Pa Downforce load ≤ 5400 Pa Compatible module type: CS6A-xxxP, CS6A-xxxM, CS6V-xxxP, CS6V-xxxM, CS6P-xxxP, CS6P-xxxM, CS6K-xxxP, CS6K-xxxM, CS6X-xxxP, CS6X-xxxM, CS6K-xxxMS, CS6V-xxxMS and CS6A-xxxMS</p>	<p>Bolting on long frame side using four innermost mounting holes. Mounting rails run parallel to the long frame side</p>  <p>Maximum Load: Uplift load ≤ 2400 Pa; Downforce load ≤ 4000 Pa (For CS6X-xxxP, CS6X-xxxM, CS6U-xxxP and CS6U-xxxM, the maximum downforce load can reach up to 5400Pa) Compatible module type: CS6A-xxxP, CS6A-xxxM, CS6V-xxxP, CS6V-xxxM, CS6P-xxxP, CS6P-xxxM, CS6K-xxxP, CS6K-xxxM, CS6X-xxxP, CS6X-xxxM, CS6U-xxxP and CS6U-xxxM</p>
<p>Bolting on long frame side using four middle mounting holes. Mounting rails run perpendicularly to the long frame side</p>  <p>Maximum Load: Uplift load ≤ 2400 Pa Downforce load ≤ 5400 Pa Compatible module type: CS6U-xxxP and CS6U-xxxM</p>	

7.0 MAINTENANCE

- **Do not** make modifications to the PV components (diode, junction box, plug connectors).
- Regular maintenance is required to keep modules clear of snow, bird droppings, seeds, pollen, leaves, branches, dirt spots, and dust.
- Modules with sufficient tilt (at least 15°), generally do not require cleaning (rain will have a self-cleaning effect). If the module has become soiled, it shall be washed with water and a non-abrasive cleaning implement (sponge) during the cool part of the day. Do not scrape or rub dry dirt away, as this may cause

AMENDED EDITIONS AND DATES

- The first edition Rev 1.1 was released in Jan, 2009.
- Rev 2.1 was amended and released in Jan, 2011.
- Rev 2.2 was amended and released in Apr, 2012.
- Rev 2.3 was amended and released in Sep, 2012.
- Rev 2.4 was amended and released in May, 2013.
- Rev 3.1 was amended and released in Apr, 2014.
- Rev 3.2 was amended and released in Dec, 2015.
- Rev 3.3 was amended and released in Mar, 2015.
- Rev 3.4 was amended and released in Mar, 2016.
- Rev 3.5 was amended and released in June, 2016.

- micro scratches.
- Snow should be removed using a soft brush.
- The system shall be periodically inspected to verify the integrity of all wiring and supports.
- To protect against electric shock or injury, electrical or mechanical inspections and maintenance should be performed by qualified personnel only and on a regular basis.
- Please refer to our Installation Manual Annex (Section Annex D: Module Cleaning Guide) for more information on module cleaning.

CANADIAN SOLAR INC.

545 Speedvale Avenue West, Guelph, Ontario, Canada N1K 1E6

www.canadiansolar.com