

Quick Installation Guide

PV Grid-Connected Inverter

SG125CX-P2 / SG110CX-P2



- Contents may be periodically updated or revised due to product development. The information in this guide is subject to change without notice. In no case shall this guide substitute for the user manual or related notes on the device.
- Make sure to read over, fully understand and strictly follow the detailed instructions of the user manual and other related regulations. Visit <http://www.sungrowpower.com/>, choose "PV Inverters" and search for the device model on the "Products" tab page to view or obtain the user manual.
- All operations can be performed only by qualified personnel, that must be trained in the installation and commissioning of the electrical system, as well as the dealing with hazards, have knowledge of the manual and of the local regulations and directives.
- Before installation, check that the package contents are intact and complete against the packing list. Contact SUNGROW or the distributor in case of any damaged or missing components.
- The cable must be intact and well insulated. Operation personnel must wear proper personal protective equipment (PPE) all the time.
- Any violation could result in personal death or injury or device damage, and will void the warranty.

Safety

Please follow the safety instructions related to the PV strings and the utility grid. Otherwise, SUNGROW shall not be held liable for any damage caused.

DANGER

Lethal voltage!

- PV strings will produce electrical power when exposed to sunlight and can cause a lethal voltage and an electric shock.
- Only qualified personnel can perform the wiring of the PV panels.
- All electrical connections must be in accordance with local and national standards.
- Only with the permission of the utility grid, the inverter can be connected to the utility grid.
- Do not open the enclosure at any time. Unauthorized opening will void guarantee and warranty claims and in most cases terminate the operating license.
- When the enclosure lid is removed, live components can be touched which can result in death or serious injury due to electric shock.

WARNING

All the warning labels and nameplate on the inverter body must be clearly visible and not be removed, covered or pasted.

CAUTION

Risk of burns due to hot components!







Do not touch any hot parts (such as heat sinks) during operation. Only the DC switch can safely be touched at any time.

NOTICE

Only qualified personnel can perform the country setting.

Unauthorized alteration of the country setting may cause a breach of the type-certificate marking.

The warning label on the inverter body are as follows.

 <p>Disconnect the inverter from all the external power sources before service!</p>	 <p>There is a danger from a hot surface that may exceed 60°C.</p>
 <p>Danger to life due to high voltages! Only qualified personnel can open and service the inverter.</p>	 <p>Check the user manual before service!</p>
  <p>Do not touch live parts until 5 minutes after disconnection from the power sources.</p>	

Scope of Delivery

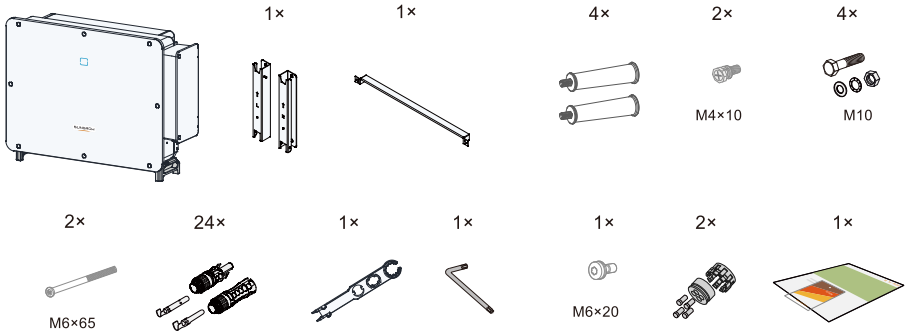

* The images shown here are for reference. The actual product and quantity are based on delivery.

Mounting location

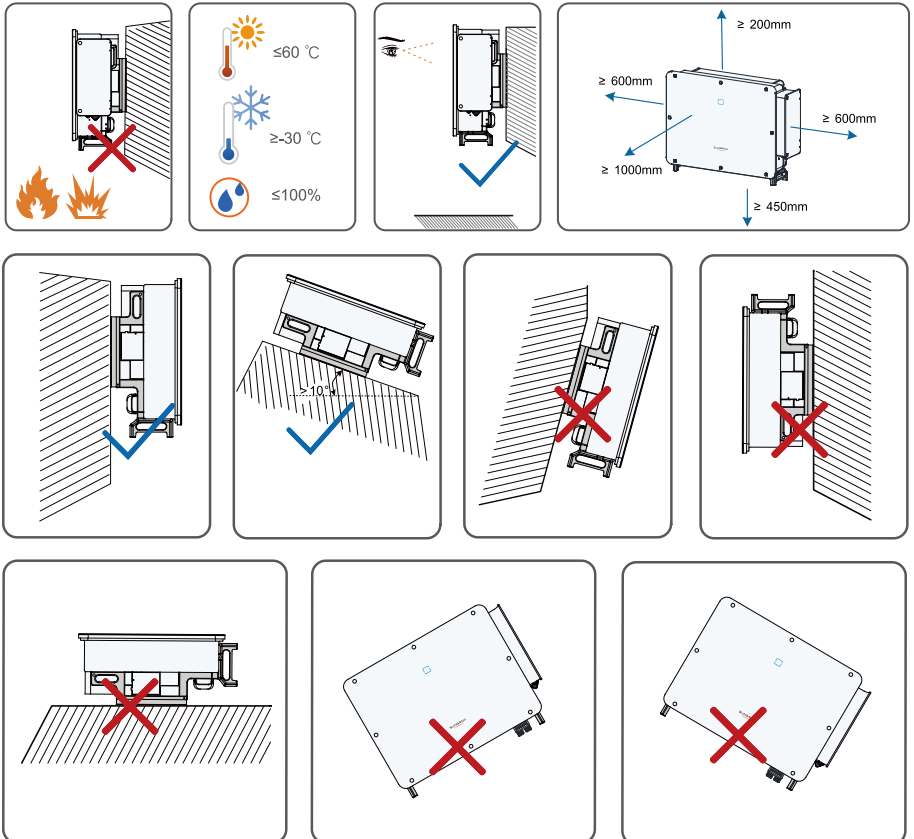

Please consult SUNGROW before tilting backwards the inverter and install it in floating power plants.

Dimension

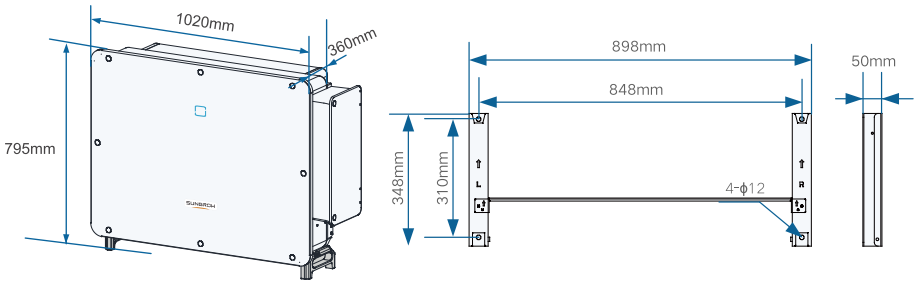

Mounting

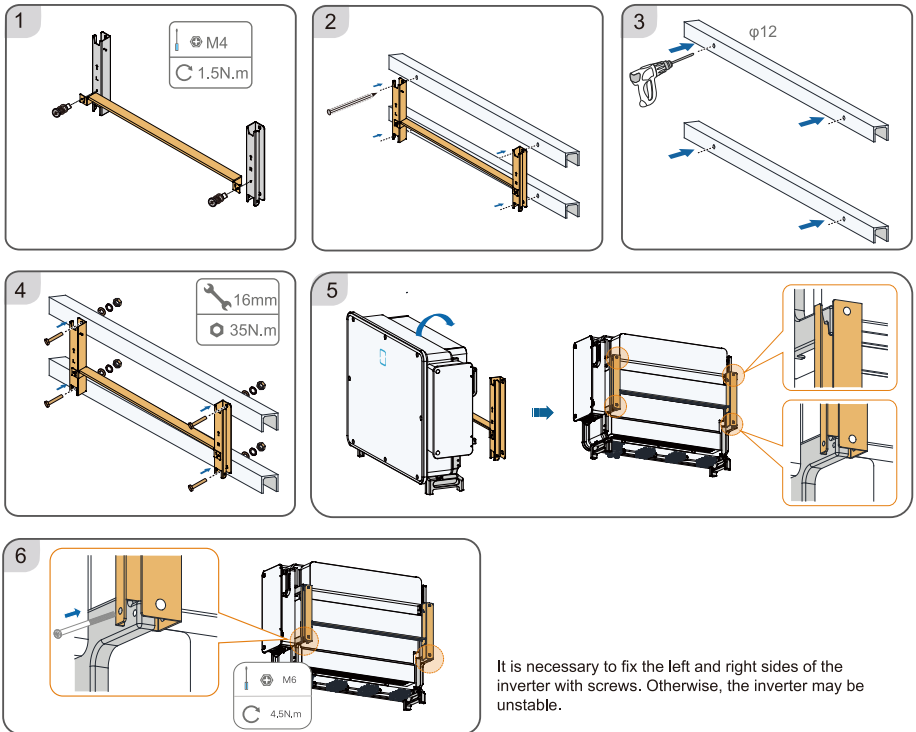

PE Connection

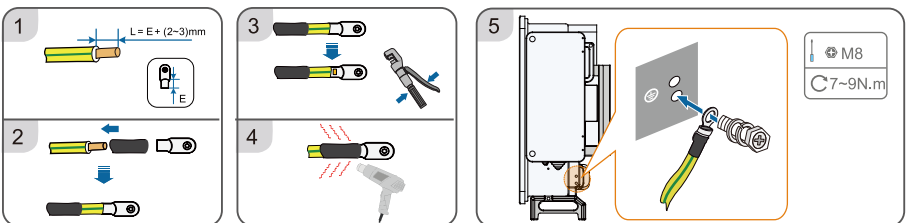

AC Connection (For a multi-core cable)

The description is given by using five-core cable as an example.

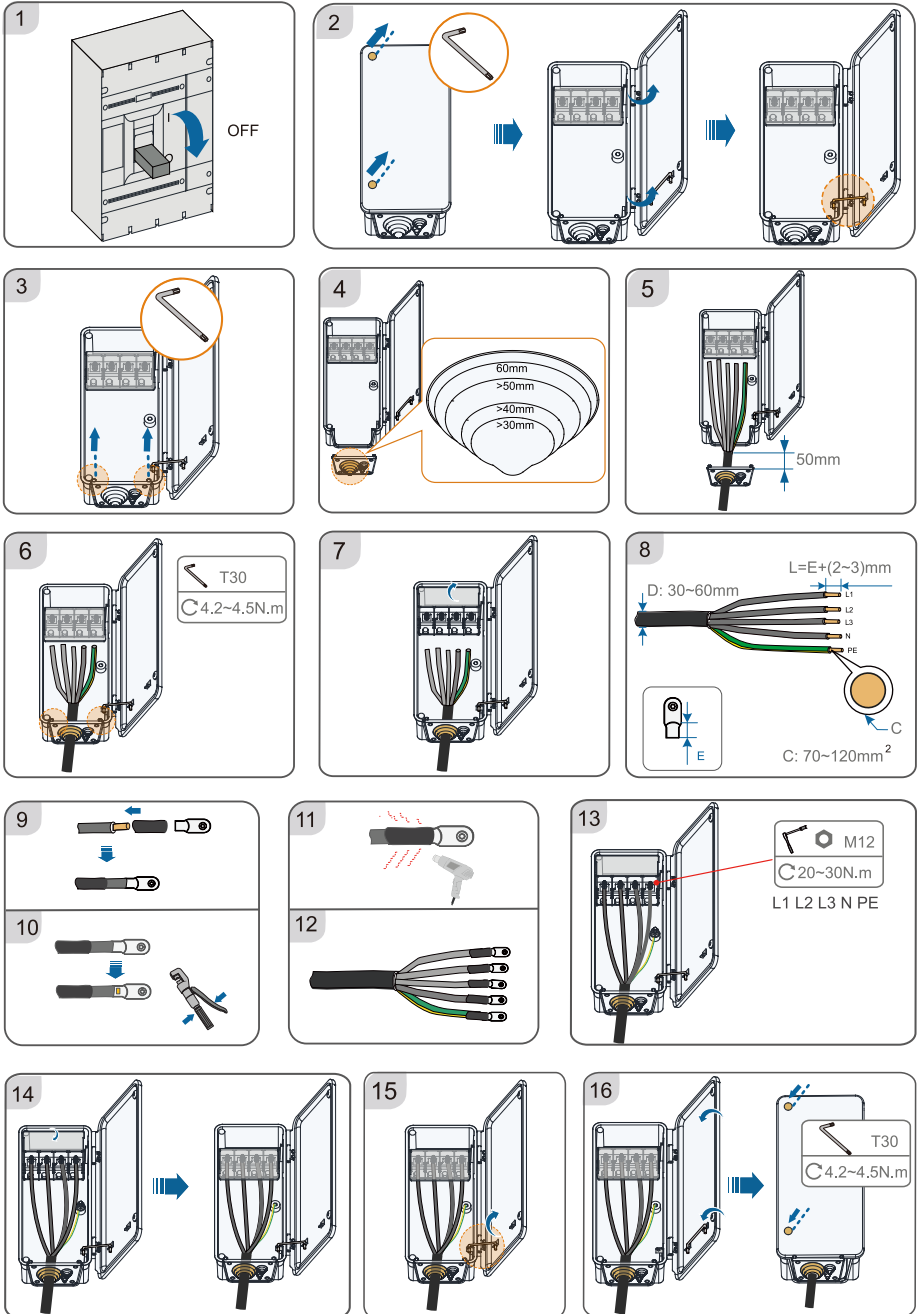

AC Connection (For a single-core cable)

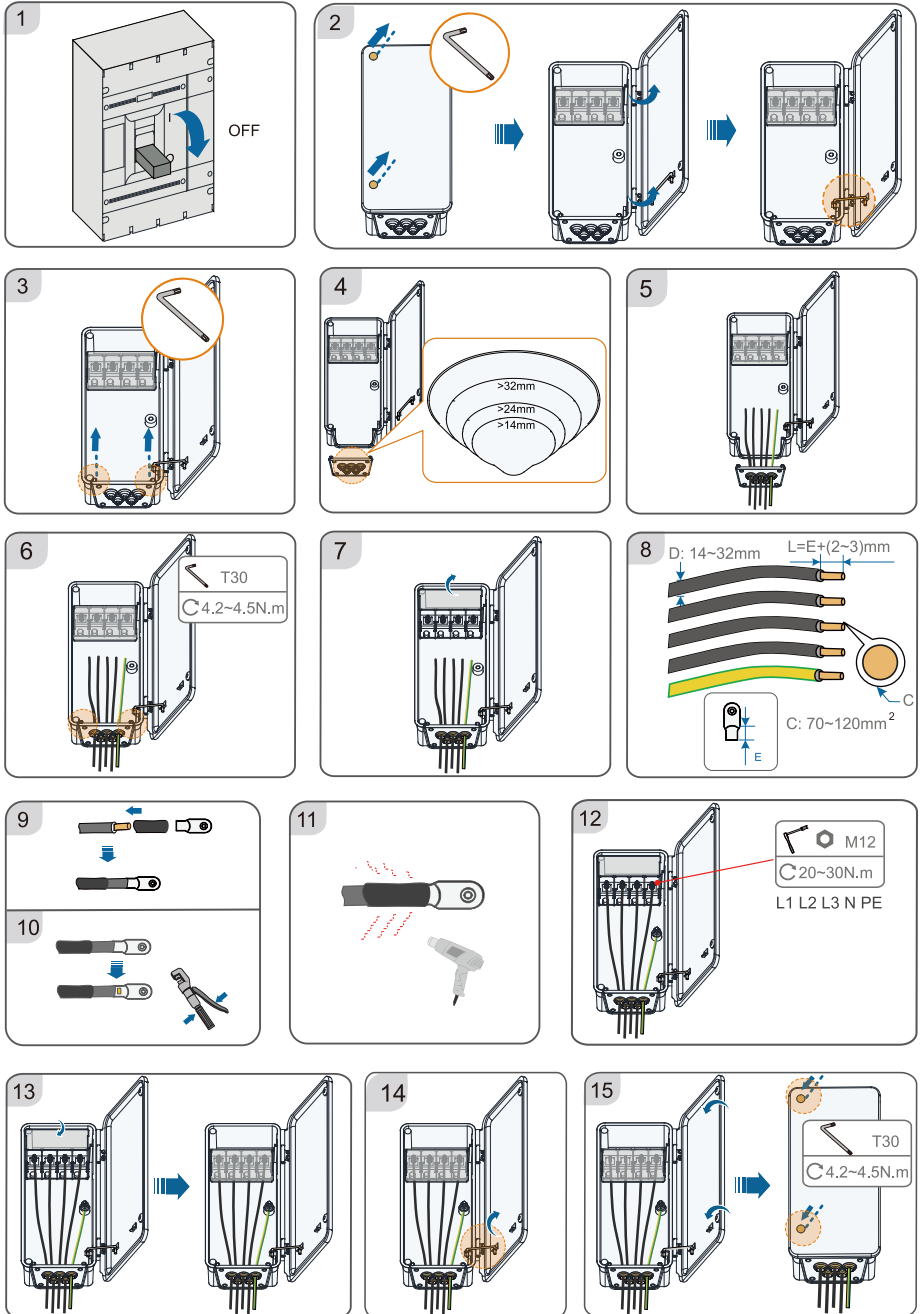

DC Connection

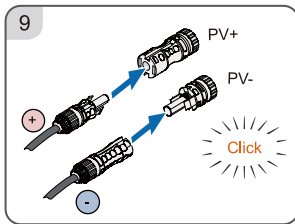
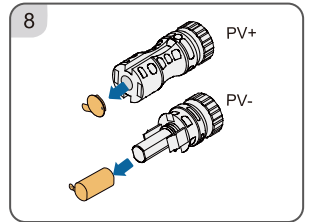
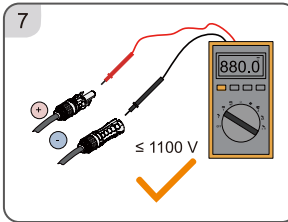
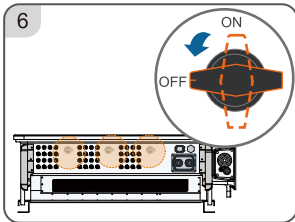
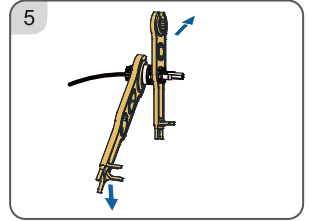
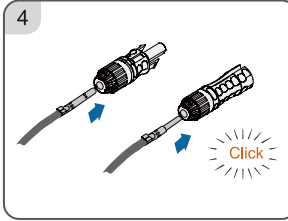
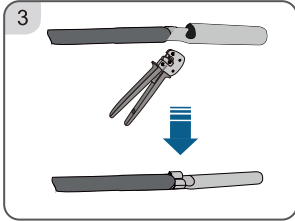
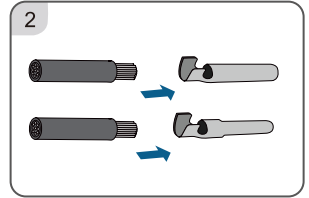
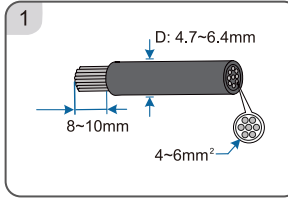
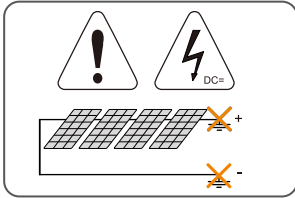

Wireless Communication Module Connection(optional)

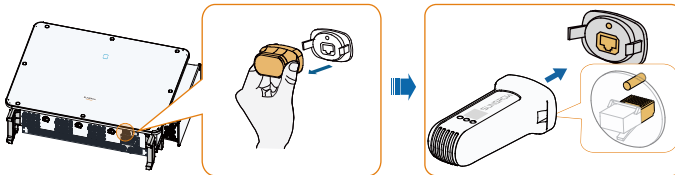

*The image shown here is for reference only. The actual product you receive may differ.

• Installation with WLAN communication

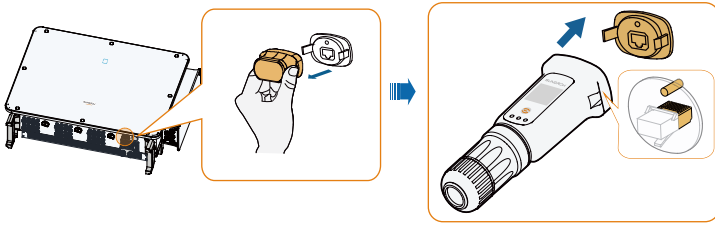

• Installation with Ethernet communication

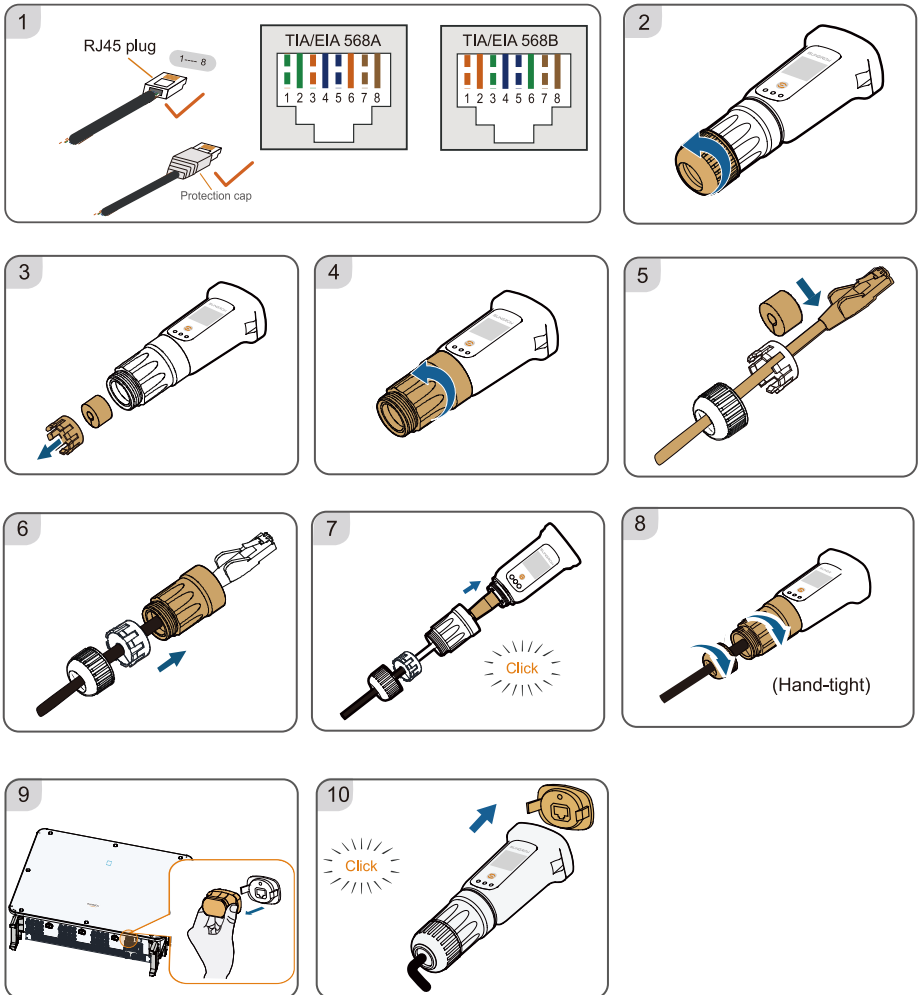

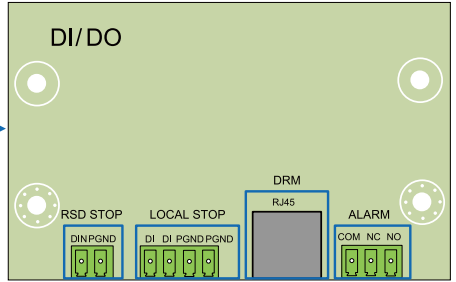
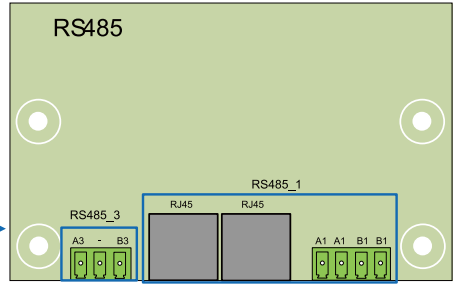
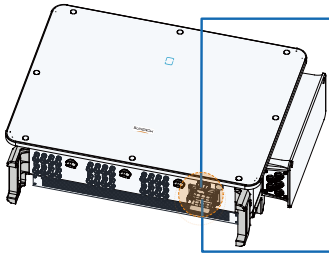

Terminal Block

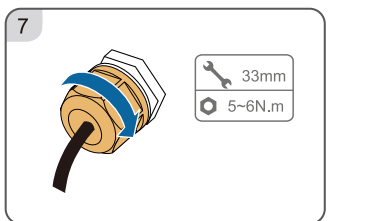
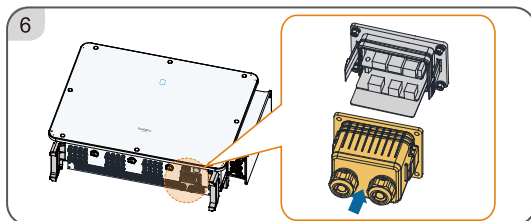
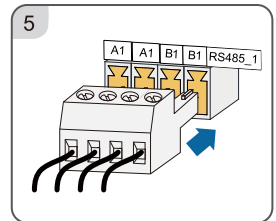
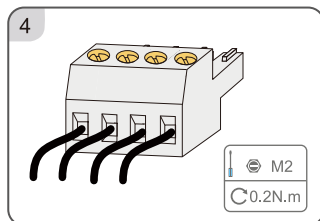
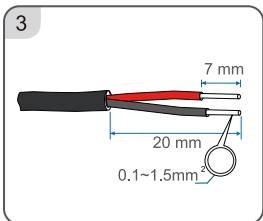
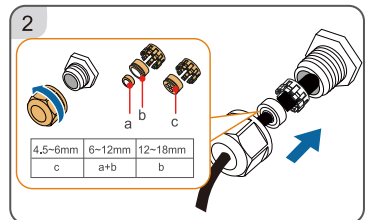
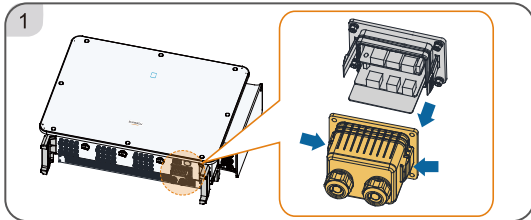

RJ45

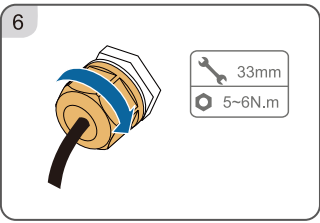
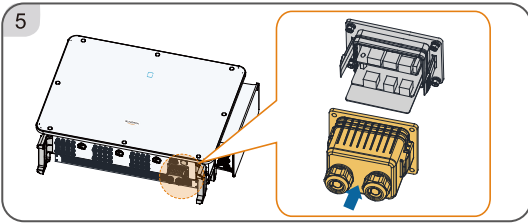
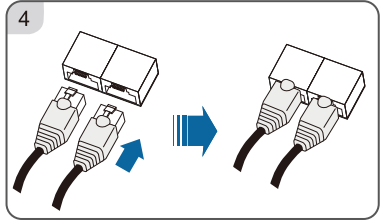
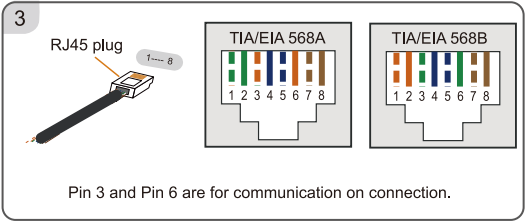
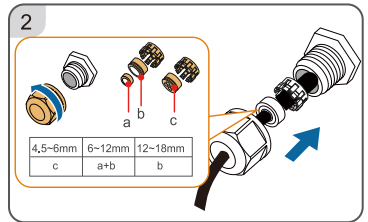
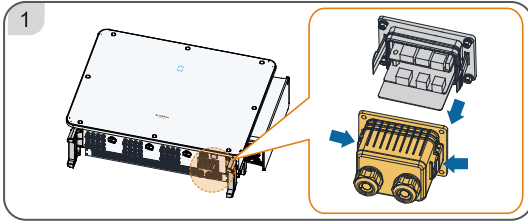

Power on

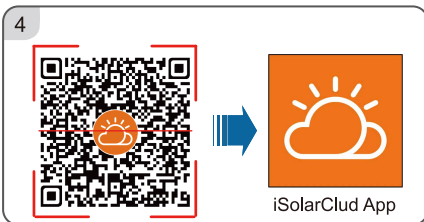
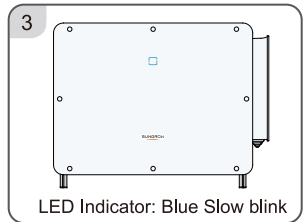
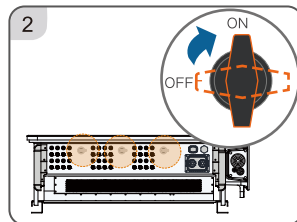
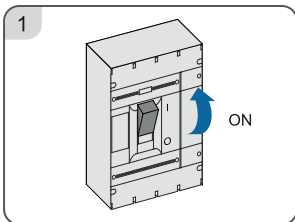

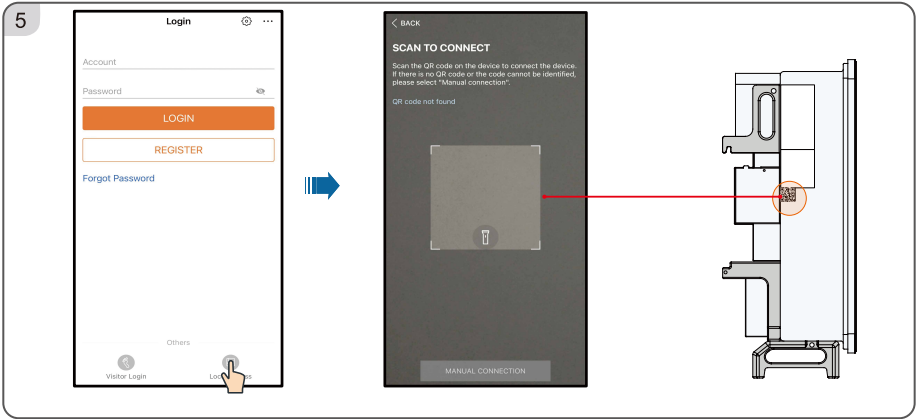

LED Indicator

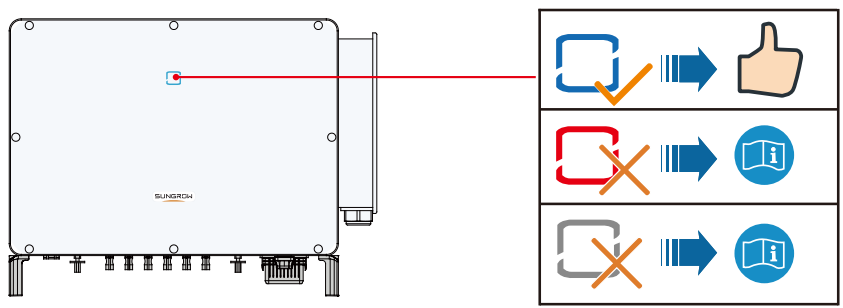



More information in the QR code or
at <http://support.sungrowpower.com/>

